

# XCG-CG Series

## Digital Video Camera Module

A new series of PoE compatible GigE Vision interface digital camera equipped with a Global Shutter CMOS Sensor.

**Exmor** **Pregius** **GiGE VISION** **PoE**



### New support functions

#### Cubic Size

- Dimensions : 29 (W) x 29 (H) x 42 (D) mm (Same dimensions as XCG-C series)

\*excluding protrusions

#### Feature-rich

- Area gain
- Defect correction
- Shading correction
- Look Up Table (LUT)
- Temperature readout
- 3 x 3 filter
- Multi ROI\*
- Binning \*\*

\*Only XCG-CG160/CG160C

\*\*Only XCG-CG160

#### System Optimization

- PoE **specification support**
- IEEE1588
- Mounting position same as XCG-C Series analogue cameras

**XCG-CG160/160C**  
1/2.9-type 1.6 MP 75 fps

**XCG-CG240/240C**  
1/1.2-type 2.4MP 41fps

**XCG-CG510/510C**  
2/3-type 5.1MP 23fps



Optimal replacement camera modules, inheriting equal size and high reliability, for CCD equipped digital and analogue cameras.

Responds to high speed and high sensitivity needs unique to Global Shutter CMOS, allowing use of various features.

Features

High Frame Rate

Select either "Frame rate priority" or "Full feature available" mode.

Model name	Frame rate priority Mode 0		Full feature available Mode 1	
	8 bit	23 fps	8/10/12 bit	15 fps
XCG-CG510 XCG-CG510C			YUV422	11 fps
			RGB24	7 fps
XCG-CG240 XCG-CG240C	8 bit	41 fps	8/10/12 bit	32 fps
	10 bit	33 fps	YUV422	25 fps
			RGB24	17 fps
XCG-CG160 XCG-CG160C	8 bit	70 fps	8/10/12 bit	45 fps
	10 bit	45 fps	YUV422	37 fps
			RGB24	25 fps

IEEE1588

IEEE1588 is a protocol that synchronizes the clock on the network. Exposure synchronization is possible with several cameras via Ethernet cable.

IEEE1588 Characteristics

- Synchronization accuracy of sub  $\mu$  seconds
- A synchronization system that isn't hardware dependent is constructible
- Composed of PTP master and slave (cameras, etc.)

Systemization simplified due to IEEE1588.

Merits

- All camera time stamps are synchronized to the master time
- Exposure synchronization in error range sub  $\mu$  seconds possible without having to connect trigger lines
- The accuracy for date and time information of time stamps enhanced.
- When time synchronization starts, shooting images will be synchronized in free run with the set interval

PTP Master Feature

When using the IEEE1588 feature, a grand master and slave composition is required.

Operating 1 camera as a master in environments where a grand master cannot be prepared allows synchronization between cameras.

An arbitrary time can be set via PC.

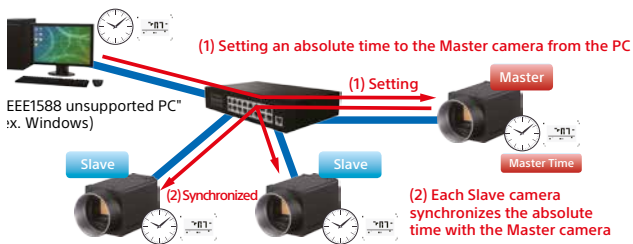

Free Set Sequence

Perform exposure several times (max. 10 patterns) and GPO output with 1 trigger signal.

You can arbitrarily set the start time and length as well as the gain of the exposure and GPO output.

The set series of exposure and GPO output is counted as 1 cycle, and this cycle can be repeated.

Merits

- Set different lighting, exposure, and gain for each different detected subject as well as perform inspection of each detected subject

Example]

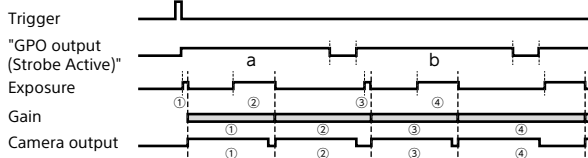

Burst Trigger

This is a feature capable of continuous shooting at the trigger timing and specifying the number of exposures, exposure interval, and exposure time.

Select from the mode that repeats one exposure time or the mode that switches between 2 exposure times repeatedly.

Furthermore, there is another mode that repeats only while the trigger signal is on.

Merits

- Optimal for capturing synchronized images with several cameras
- Optimal when 2 exposures are necessary due to the difference in brightness of the subject

(A) When 1 pattern of exposure time is set

Set the number of exposures (1), exposure interval (2), and exposure time (3)

Continuous shooting at the trigger timing

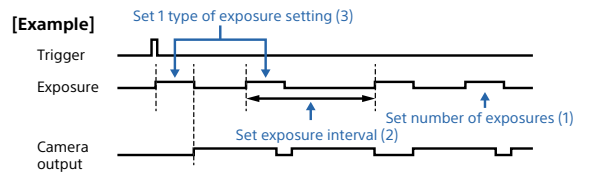

(B) When 2 patterns of exposure times are set

Set the number of exposures (1), exposure interval (2), and exposure time (3)

Continuous shooting at the trigger timing

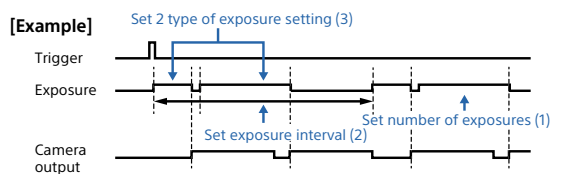

Bandwidth Control Feature

(1) Memory shot (when shooting continuously)

This feature allows you to save a specified amount of camera images to the camera and perform image output at your desired timing.

Optimal when requiring simultaneous exposure, but there are several cameras connected to the same network and the configuration makes the bandwidth exceed 1Gbps when operated simultaneously.

Optimal when shooting several shots.

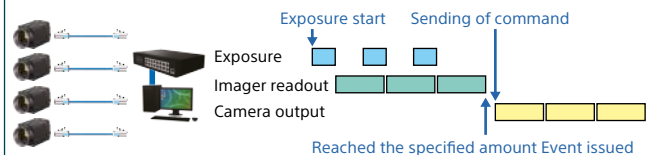

(2) Output timing control (when shooting 1 shot with 1 trigger)

Normally, images are sequentially output when exposure ends, but the image output start timing can be delayed.

Optimal when requiring simultaneous exposure, but there are several cameras connected to the same network and the configuration makes the bandwidth exceed 1Gbps when operated simultaneously.

Optimal when shooting 1 shot with single frame or trigger.

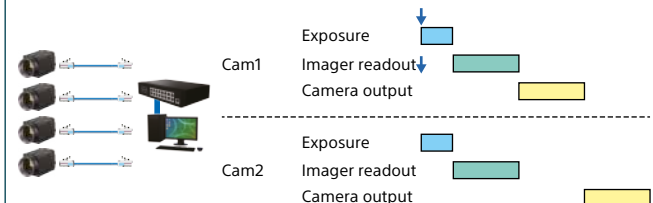

## Area Gain

Individually set digital gain (0 to 32 times) to any of the 16 rectangular areas.

If several rectangular areas overlap, the gain value of the rectangular area with a smaller area number is prioritized. Optimization of images for parts is available during parts inspection, etc.

When area gain is OFF

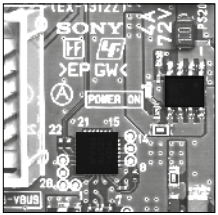

\*Sample image

When area gain is ON

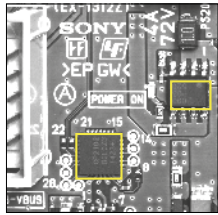

\*Sample image

In case setting Gain=2 at Area 0 and Area 1

## Multi ROI

\*Only XCG-CG160/CG160C

Arbitrarily read out images including any 2 (max.) rectangular area from the maximum effective imaging area.

Due to this, you will be capable of limiting read out information, thus accelerating the frame rate.

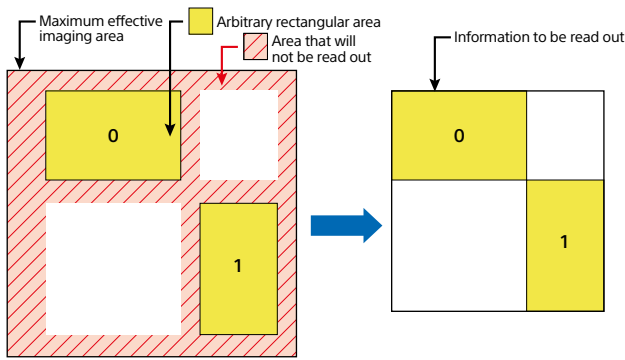

## Binning

\*only XCG-CG160

Supports binning in vertical and horizontal 2 pixel units and increases frame rate without changing the angle of view as well as enhances the sensitivity.

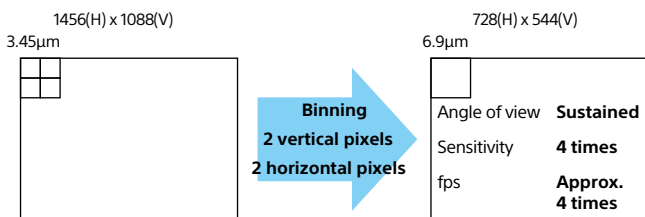
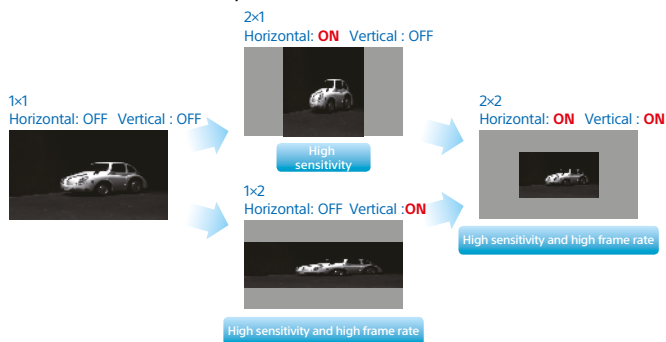

## Trigger Range Limitation

You can choose to receive only the signal of the set trigger width as a trigger signal.

It functions as a noise filter that eliminates chattering and disturbance noise of the trigger signal line.

Furthermore, exposure start can be delayed following the set value of the trigger range if a trigger signal is input.

## Defect Correction

Corrects white defect points and black defect points of the image sensor.

Corrections start from the periphery of the pixel coordinates where defects were detected.

Select between factory default settings and user settings.

## 3 x 3 Filter

Apply various processing to the image through matrix operating in 3 x 3 pixels.

Perform processing including noise reduction, edge emphasizing, and contour extraction with 9 filter factor patterns.

## Shading Correction

Corrects shading that occurs due to peripheral light falloff, light source irregularity, etc. that are characteristics of the lens.

A number of user data can be saved as user settings.

- XCG-CG510/CG510C : 9 patterns
- XCG-CG240/CG240C : 20 patterns
- XCG-CG160/CG160C : 35 patterns

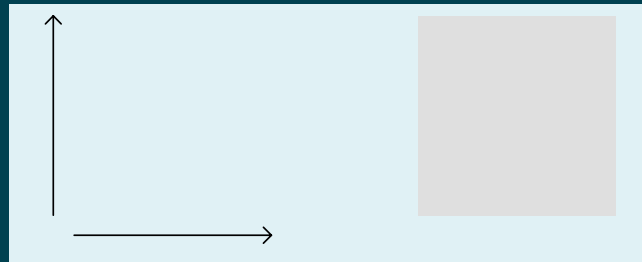

## Image Flip

Images can be flipped vertically, horizontally, or 180°.

		ReverseX	
		0	1
ReverseY	0	Normal	Horizontal flip
	1	Vertical flip	180° rotation

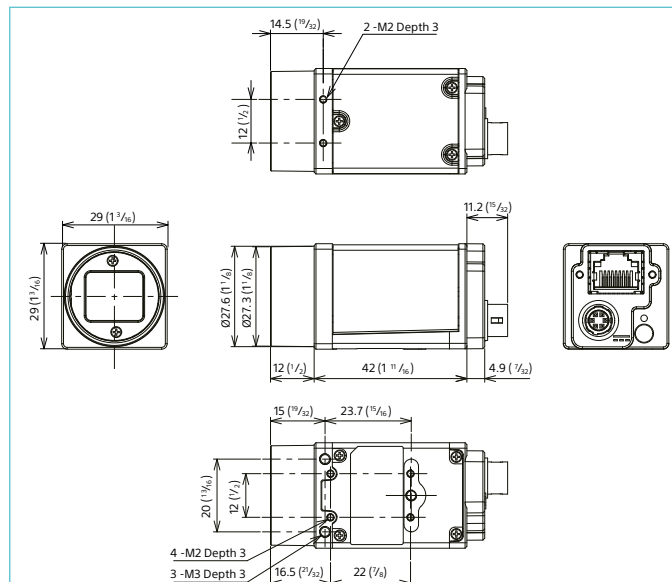

# XCG-CG Series - Specifications

	5.1M GigE Vision®		2.4M GigE Vision®		1.6M GigE Vision®	
Basic Specifications	XCG-CG510	XCG-CG510C	XCG-CG240	XCG-CG240C	XCG-CG160	XCG-CG160C
B/W / Colour	B/W / Colour		B/W / Colour		B/W / Colour	
Image Size	5.1 Mega		2.4 Mega		1.6 Mega	
Image Sensor	2/3-type CMOS Image sensors with a global shutter function (Pregius)		1/1.2-type CMOS Image sensors with a global shutter function (Pregius)		1/2.9-type CMOS Image sensors with a global shutter function (Pregius)	
Number of Effective Pixels (H x V)	2,464 × 2,056		1,936 × 1,216		1,456 × 1,088	
Cell Size (H x V)	3.45 μm × 3.45 μm		5.86 μm × 5.86 μm		3.45 μm × 3.45 μm	
Standard Output Pixels (H x V)	2,448 × 2,048		1,920 × 1,200		1,440 × 1,080	
Colour Filter	-	RGB colour mosaic filter	-	RGB colour mosaic filter	-	RGB colour mosaic filter
Frame Rate	23 fps (8 bit, Mono/Raw)		41 fps (8 bit, Mono/Raw) 33 fps (10 bit, Mono/Raw)		75 fps (8 bit, Mono/Raw) 45 fps (10 bit, Mono/Raw)	
Minimum Illumination	0.5 lx (Iris: F1.4, Gain: +18 dB, Shutter: 1/23 s)	10 lx (Iris: F1.4, Gain: +18 dB, Shutter: 1/23 s)	0.5 lx (Iris: F1.4, Gain: +18 dB, Shutter: 1/30 s)	10 lx (Iris: F1.4, Gain: +18 dB, Shutter: 1/30 s)	0.5 lx (Iris: F1.4, Gain: +18 dB, Shutter: 1/30 s)	12 lx (Iris: F1.4, Gain: +18 dB, Shutter: 1/30 s)
Sensitivity	F8 (400 lx, Gain: 0 dB, Shutter: 1/23 s)	F8 (2000 lx, Gain: 0 dB, Shutter: 1/23 s)	F5.6 (400 lx, Gain: 0 dB, Shutter: 1/30 s)	F5.6 (2000 lx, Gain: 0 dB, Shutter: 1/30 s)	F5.6 (400 lx, Gain: 0 dB, Shutter: 1/30 s)	F5.6 (2000 lx, Gain: 0 dB, Shutter: 1/30 s)
SNR	More than 50 dB (Lens close, Gain: 0 dB, 8 bit)					
Gain	Auto, Manual: 0 dB to 18 dB					
Shutter Speed	Auto, Manual: 60 to 1/100,000 s		Auto, Manual: 60 to 1/40,000 s		Auto, Manual: 60 to 1/100,000 s	
White Balance	-	Manual, One push, Auto	-	Manual, One push, Auto	-	Manual, One push, Auto
Camera Features						
Readout Modes	Normal, Partial scan				Normal, Binning (1x2, 2x1, 2x2), Partial scan (Multi ROI)	Normal, Partial scan (Multi ROI)
Readout Features	LUT (Binarization, Gamma (Arbitrary value settable)), Test pattern					
Synchronization	Hardware trigger, Software trigger, PTP (IEEE1588)					
Trigger Modes	OFF (Free run), ON (Edge detection, Trigger width detection), Special trigger (Burst trigger, Bulk trigger, Sequential trigger, Free set sequence)					
Userset	16					
User Memory	64 bytes × 16 ch					
Partial Scan	W (Pixel)	16 to 2,464	16 to 1,936	16 to 1,936	16 to 1,456	16 to 1,456
	H (Line)	16 to 2,056	16 to 1,216	16 to 1,216	16 to 1,088	16 to 1,088
GPO	EXPOSURE/Strobe/Sensor lead out/Trigger through/Pulse generation signal/User defined 1, 2, 3 (Output switching)					
Other Features	Area gain, Defect correction, Shading correction, Temperature readout, LUT, 3 × 3 filter					
Interface						
Video Data Output	digital Mono 8, 10, 12 bit (at the time of shipment 8 bit)	digital Raw 8, 10, 12 bit (at the time of shipment Raw 8 bit) RGB, YUV422, YUV444	digital Mono 8, 10, 12 bit (at the time of shipment 8 bit)	digital Raw 8, 10, 12 bit (at the time of shipment Raw 8 bit) RGB, YUV422, YUV444	digital Mono 8, 10, 12 bit (at the time of shipment 8 bit)	digital Raw 8, 10, 12 bit (at the time of shipment Raw 8 bit) RGB, YUV422, YUV444
Digital Interface	Gigabit Ethernet (1000BASE-T/100BASE-TX)					
Camera Specification	GigE Vision® Version 2.0/1.2					
Digital I/O	ISO IN (x1), TTL IN/OUT (x2, selectable)				ISO IN (x1), ISO OUT (x1), TTL IN/OUT (x1, selectable)	
General						
Lens Mount	C mount					
Flange Back	17.526 mm					
Power Requirements	DC +12 V (10.5 V to 15.0 V), IEEE802.3af (37 V to 57 V)					
Power Consumption	DC+12V 3.0 W (max.)		DC+12V 3.0 W (max.)		DC+12V 3.3 W (max.)	
	IEEE802.3af 3.7 W (max.)		IEEE802.3af 3.6 W (max.)		IEEE802.3af 4.0 W (max.)	
Operating Temperature	-5°C to +45°C (23°F to 113°F)					
Performance Guarantee Temperature	0°C to 40°C (32°F to 104°F)					
Storage Temperature	-30°C to +60°C (-22°F to +140°F)					
Operating Humidity	20% to 80% (no condensation)					
Storage Humidity	20% to 95% (no condensation)					
Vibration Resistance	10 G (20 Hz to 200 Hz 20 minutes for each direction -x, y, z)					
Shock Resistance	70 G					
Dimensions (W x H x D)	29 × 29 × 42 mm (excluding protrusions) 13/16 × 13/16 × 111/16 inches (excluding protrusion)					
Mass	Approx. 65 g (Approx. 2.3 oz)					
MTBF	62,042 hours (Approx. 7.1 years)		63,172 hours (Approx. 7.2 years)		58,525 hours (Approx. 6.7 years)	
Regulations	UL60950-1, FCC Class A, CSA C22.2-No. 60950-1, IC Class A Digital Device, CE: EN61326 (Class A), AS EMC: EN61326-1, VCCI Class A, KCC, CISPR22/24+IEC61000-3-2/-3					
Supplied Accessories	Lens mount cap (1), Operating instructions (1)					

Distributed by

©2017 Sony Imaging Products & Solutions Inc. Reproduction in whole or in part without written permission is prohibited. Features and specifications are subject to change without notice. The values for mass and dimension are approximate. "SONY" is a registered trademark of Sony Corporation. Pregius and Exmor R are trademark of Sony Corporation. All other trademarks are the property of their respective owners. Please visit Sony's professional website or contact your Sony representative for specific models available in your region.  
PHC\_03/10/2017

**SONY**